

RBP 500

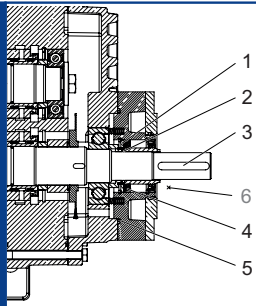

SERVICE

BECKER
D-42279 Wuppertal
www.becker-international.com

No. **B** year XXXX

type **RBP 500-XX** Index Variante

frequency XXXX Hz

speed XXXX min⁻¹

power required XXXX kW

inlet capacity XXXX m³/h

pressure + XXXX mbar

vacuum - XXXX mbar

Made in Germany

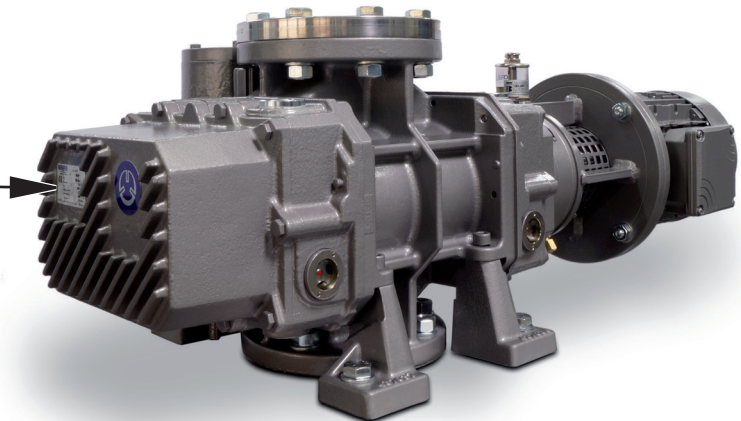

Ersatzteilliste
Spare parts list
Liste de pièces de rechange
Listino pezzi di ricambio
Lista de piezas de recambio
Lista de peças sobresselentes
Reserveonderdelenlijst
Atsarginių dalių sąrašas
Varuosad nimekirja
Rezerves daļu saraksts

Reservedelsliste
Reservdelslista
Varaosuettelo
Reservedelsliste
Wykaz części zamiennych
Tartalékalkatrész lista
Seznam náhradních dílů
Seznam nadomestnih delov
Zoznam náhradných dielov
Rezervni dijelovi popis

Lista pieselor de schimb
Páirteanna spártha liosta
Κατάλογος ανταλλακτικών
Yedek parça listesi
Списък на резервните части
Перечень запасных частей
スベアパーツリスト
예비 부품 목록
备用零件目录

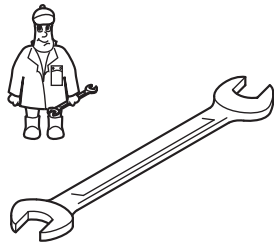

Wartung
Maintenance
Entretien
Manutenzione
Mantenimiento

Pos.	Menge Quantity Quantité Quantità Cantidad	Bestell-Nr. Ident No. No. Identification No. Identificazione No. de pedido	Bezeichnung Description Designation Designazione Descripción
K1	1	966500 58400	⇒ RBP 500 Wartungssatz, Maintenance kit, Kit de maintenance, Kit di manutenzione, Kit de mantenimiento
K2	1	966500 58700	Ölblausschraubensatz, Oil drain screw kit, Kit de vis de vidange d'huile, Kit di vite di scarico dell'olio, Kit de tornillo de drenaje de aceite
K3	1	966500 58800	Ölschaugglas + Dichtung, Oil sight glass + gasket, Jauge d'huile + joint, Spia livello olio + guarnizione, Mirilla de aceite + guarnición
K4	1	955300 55400	Tropföleriset, Drip oiler kit, Kit de graisseur goutte à goutte, Kit oliatore a goccia, Kit de engrase por goteo



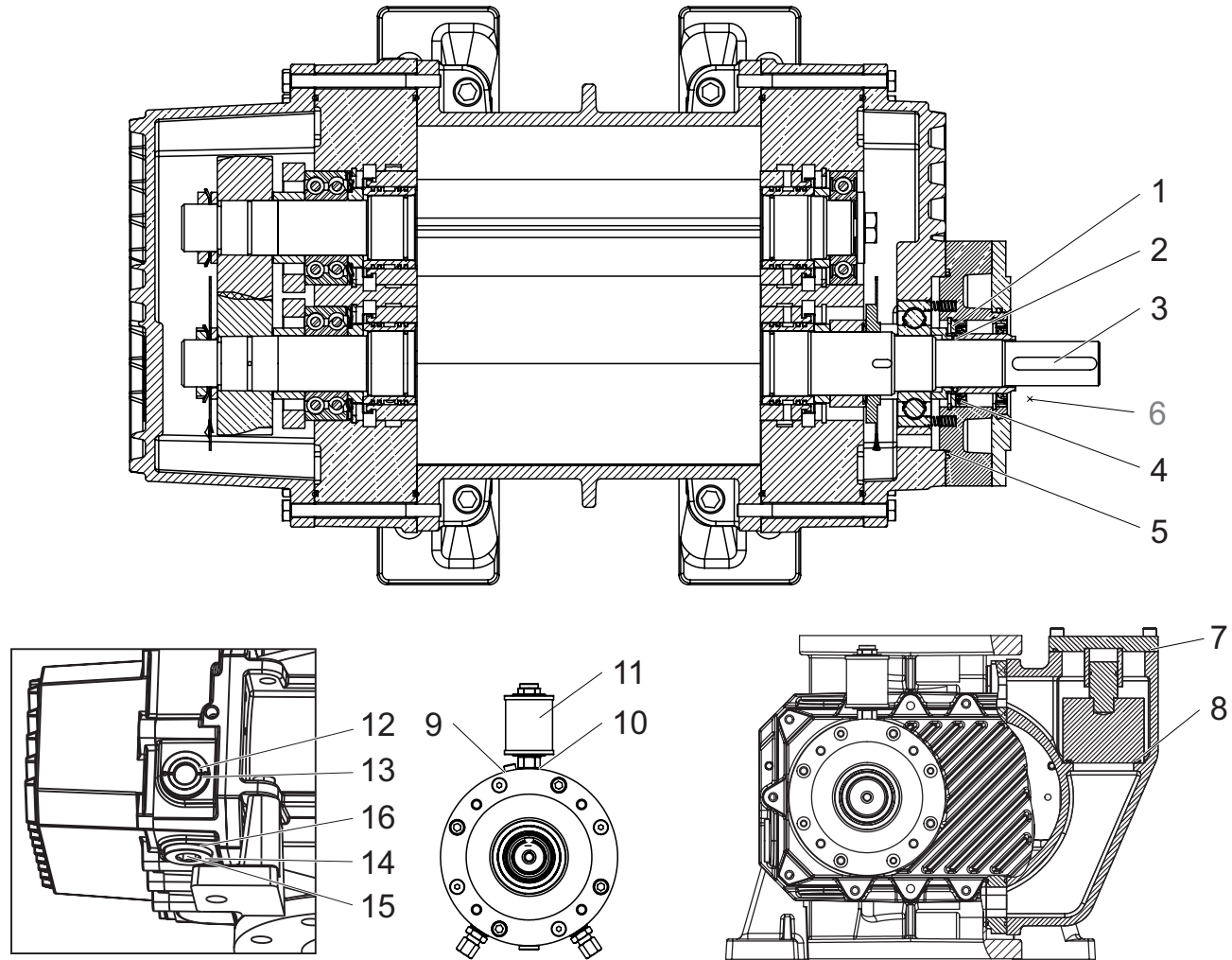

28000058401 06/2018

RBP 500



- INDEX	Pos.	Bestell Nr.	Beschreibung	
RBP 500	K1	966500 58400	WARTUNGSSATZ	
	K2	966500 58700	ÖLABLASSSCHRAUBENSATZ	
	K3	966500 58500	ÖLSCHAUGLAS + DICHTUNG	
	K4	955300 55400	TROPFÖLERSATZ	
	1	K1	WELLENDICHRING-UNTERLEGSSCHEIBE	
	2	K1	O-RING	
	3	K1	PASSFEDER	
	4	K1	WELLENDICHRING	
	5	K1	O-RING	
	6	K1	KUPPLUNGSRING	
	7	K1	O-RING	
	8	K1	O-RING	
	9	K1	KUPFERDICHRING	
	10	K1, K4	ALUMINIUMSCHEIBE	
	11	K4	TROPFÖLER	
	12	K3	ÖLSCHAUGLAS	
13	K3	O-RING		
14	K2	ÖLABLASSSCHRAUBE		
15	K2	SCHRAUBENKAPPE		
16	K2	O-RING		

- INDICE	Pos.	No. identifikation	Designation	
RBP 500	K1	966500 58400	KIT DE MAINTENANCE	
	K2	966500 58700	KIT DE VIS DE VIDANGE D'HUILE	
	K3	966500 58500	JAUGE D'HUILE + JOINT	
	K4	955300 55400	KIT DE GRAISSEUR GOUTTE À GOUTTE	
	1	K1	RONDELLE D'ÉTANCHÉITÉ	
	2	K1	JOINT TORIQUE	
	3	K1	CLAVETTE	
	4	K1	BAGUE D'ÉTANCHEITE	
	5	K1	JOINT TORIQUE	
	6	K1	DISQUE D'ACCOUPLMENT	
	7	K1	JOINT TORIQUE	
	8	K1	JOINT TORIQUE	
	9	K1	BAGUE D'ÉTANCHÉITÉ EN CUIVRE	
	10	K1, K4	BAGUE D'ÉTANCHÉITÉ EN ALUMINIUM	
	11	K4	GRAISSEUR GOUTTE À GOUTTE	
	12	K3	JAUGE D'HUILE	
13	K3	JOINT TORIQUE		
14	K2	VIS DE VIDANGE D'HUILE		
15	K2	BOUCHON FILETÉ		
16	K2	JOINT TORIQUE		

- INDEX	Pos.	Ident No.	Description	
RBP 500	K1	966500 58400	RBP 500 - MAINTENANCE KIT	
	K2	966500 58700	OIL DRAIN SCREW KIT	
	K3	966500 58500	OIL SIGHT GLASS + GASKET	
	K4	955300 55400	DRIP OILER KIT	
	1	K1	SHAFT SEAL BACKING WASHER	
	2	K1	O-RING	
	3	K1	KEY	
	4	K1	SHAFT SEAL	
	5	K1	O-RING	
	6	K1	COUPLING RING	
	7	K1	O-RING	
	8	K1	O-RING	
	9	K1	COPPER SEAL RING	
	10	K1, K4	ALUMINIUM WASHER	
	11	K4	DRIP OILER	
	12	K3	OIL SIGHT GLASS	
13	K3	O-RING		
14	K2	OIL DRAIN CREW		
15	K2	SCREW CAP		
16	K2	O-RING		

- INDICE	Pos.	No. identificazione	Designazione	
RBP 500	K1	966500 58400	KIT DI MANUTENZIONE	
	K2	966500 58700	KIT DI VITE DI SCAICO DELL'OLIO	
	K3	966500 58500	SPIA LIVELLO OLIO + GUARNIZIONE	
	K4	955300 55400	KIT OLEATORE A GOCCIA	
	1	K1	RONDELLA DI TENUTA DELL'ALBERO	
	2	K1	GUARNIZIONE CIRCOLARE	
	3	K1	CHIAVETTA	
	4	K1	GUARNIZIONE PER L'ALBERO	
	5	K1	GUARNIZIONE CIRCOLARE	
	6	K1	DISCO GIUNTO	
	7	K1	GUARNIZIONE CIRCOLARE	
	8	K1	GUARNIZIONE CIRCOLARE	
	9	K1	ANELLO DI TENUTA DI RAME	
	10	K1, K4	ANELLO DI TENUTA DI ALLUMINIO	
	11	K4	OLEATORE A GOCCIA	
	12	K3	SPIA LIVELLO OLIO	
13	K3	GUARNIZIONE CIRCOLARE		
14	K2	VITE DI SCAICO DELL'OLIO		
15	K2	TAPPO A VITE		
16	K2	GUARNIZIONE CIRCOLARE		

- INDEX	Pos.	Bestell Nr.	Beschreibung		
RBP 500	K1	966500 58400	KIT DE MANTENIMIENTO		
	K2	966500 58700	KIT DE TORNILLO DE DRENAJE DE ACEITE		
	K3	966500 58500	MIRILLA DE ACEITE + GUARNICIÓN		
	K4	955300 55400	KIT DE ENGRASE POR GOTEÓ		
	1	K1	ARANDELA DE ARO DE RETENCIÓN		
	2	K1	ANILLO TÓRICO		
	3	K1	CHAVETA		
	4	K1	ARO DE RETENCIÓN		
	5	K1	ANILLO TÓRICO		
	6	K1	DISCO DE ACOPLAMIENTO		
	7	K1	ANILLO TÓRICO		
	8	K1	ANILLO TÓRICO		
	9	K1	ANILLO DE JUNTA DE COBRE		
	10	K1, K4	ANILLO DE JUNTA DE ALUMINIO		
	11	K4	ENGRASE POR GOTEÓ		
	12	K3	MIRILLA DE ACEITE		
13	K3	ANILLO TÓRICO			
14	K2	TORNILLO DE DRENAJE DE ACEITE			
15	K2	TAPÓN ROSCADO			
16	K2	ANILLO TÓRICO			